

CEDARSHED PRODUCTS-MATERIAL SPECIFICATION SHEETS

		sheds	gazebos	enclosed gazebos
floor	selected grade and better	2x4 joist 5/8" plywood	2x4 joist 1 1/2" thick deck boards	2x4 joist 1 1/2" thick deck boards
framing	selected grade and better	2x3 framing	2x4 framing 2x4 beveled posts	2x4 framing 2x4 beveled posts
Walls		6 ft high	7 ft high	7 ft high
	selected grade and better	1/2" bevel	shaped handrail 2x2 baluster sidewall	3/4" thick grooved cedar paneling
Door Hardware	Dutch door	black powdered coated steel		
	double door	black powdered coated steel		black wrought iron
	sliding door	black powdered coated steel aluminum double track with 4 wheeled hangers (2)		
	solid door	antique nickel finish locking door set		
	screen door		black screen door set with spring hinges	
Windows	all windows	1/8" plexiglas		1/8" plexiglas
	Sunhouse Specific	1/4" thermoclear 1/2" foam tape		
Window Hardware	all windows	black powder coated steel		black powder coated steel
	sliding windows	aluminum double track with 4 wheeled hangers (2)		aluminum double track with 4 wheeled hangers (2)
Roof		1/2" tapersawn shakes 15 lb. roofing felt 3/4" thick cedar roof batten	1/2" tapersawn shakes 15 lb. roofing felt 3/4" thick cedar grooved paneling	1/2" tapersawn shakes 15 lb. roofing felt 3/4" thick cedar grooved paneling
Trim Pieces	selected grade and better	3/4" thick cedar	3/4" thick cedar	3/4" thick cedar
Fasteners	screws	ceramic coated screws	ceramic coated screws	ceramic coated screws
	nails	hot dipped galvanized	hot dipped galvanized	hot dipped galvanized
	SunHouse Specific	screws with neoprene washers		
Gazebo Screen Kits			1" thick cedar frames .185" black spine 16x18 hole/in. black fiberglass screening	1" thick cedar frames .185" black spine 16x18 hole/in. black fiberglass screening

GABLE GARDEN SHED (6 Ft Wide) MEASUREMENTS

The specifications outlined here are the basic measurements for the gable garden sheds. For specifications for any unique styles of sheds please refer to the specific pages for each model included in this book.

All window and door dimensions are outlined in the individual product information sheets.

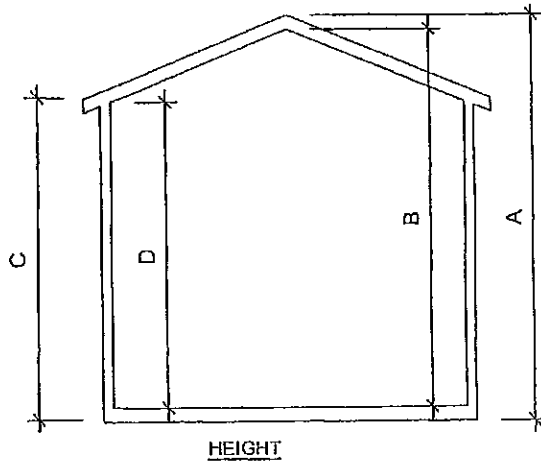

PLEASE NOTE SPECIALTY SHEDS, SUCH AS THE SUNHOUSE, PLAYHOUSES, AND LEAN TO STYLE SHEDS WILL HAVE THEIR OWN SPECIFICATION SHEETS INCLUDED IN THIS BOOK.

MEASUREMENTS FOR GABLE SHEDS							
6 FT. GABLE WALL							
SIZE	6' x 6'		6' x 9' or 9' x 6'		6' x 12' or 12' x 6'		
	imperial (in.)	metric (cm.)	imperial (in.)	metric (cm.)	imperial (in.)	metric (cm.)	
inside area	30.7 sq. ft.	2.9 sq. m.	46.1 sq. ft.	4.36 sq. m.	61.4 sq. ft.	5.81 sq. m.	
H							
E	A	99	2515	99	1515	99	2515
I	B	88	2235	88	2235	88	2235
G	C	80	2032	80	2032	80	2032
H	D	75 1/4	1911	75 1/4	1911	75 1/4	1911
T							
W							
I	E	83	2101	83	2101	83	2101
D	F	69	1753	69	1753	69	1753
T	G	64	1626	64	1626	64	1626
H							
D							
E	H	87	2210	122	3099	156 1/2	3975
P	I	74	1880	108 5/8	2759	143 1/8	3635
T	J	69	1753	103 5/8	2632	138 1/8	3508
H							

NOTE: When the 7 ft wall option is purchased the all the HEIGHT measurements will be 12" (30.5 cm) larger.

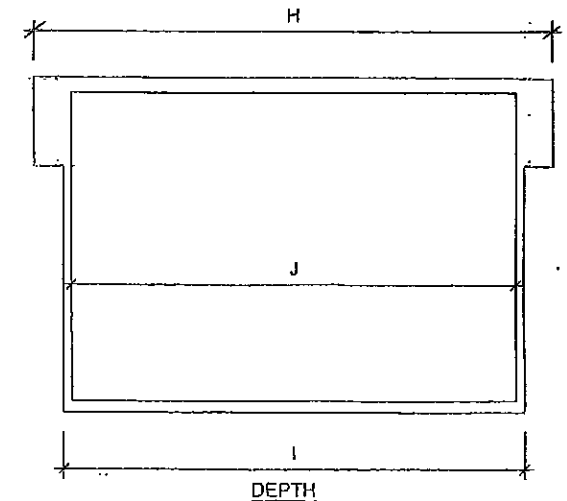
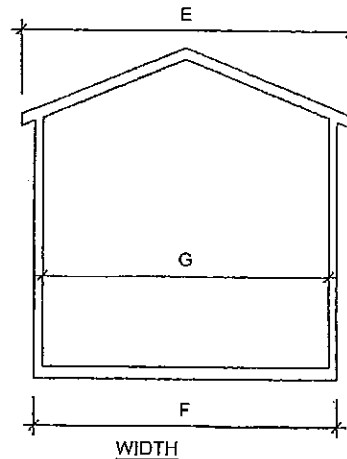

GABLE GARDEN SHED (8 Ft Wide) MEASUREMENTS

The specifications outlined here are the basic measurements for the gable garden sheds. For specifications for any unique styles of sheds please refer to the specific pages for each model included in this book.

All window and door dimensions are outlined in the individual product information sheets.

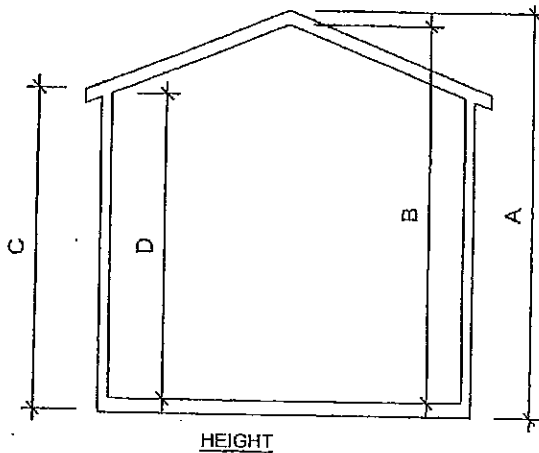

PLEASE NOTE SPECIALTY SHEDS, SUCH AS THE SUNHOUSE, PLAYHOUSES, AND LEAN TO STYLE SHEDS WILL HAVE THEIR OWN SPECIFICATION SHEETS INCLUDED IN THIS BOOK.

MEASUREMENTS FOR GABLE SHEDS									
8 FT. GABLE WALL									
SIZE	8' x 10' or 10' x 8"		8' x 12' or 12' x 8'		8' x 16' or 16' x 8'		8' x 20' or 20' x 8'		
	imperial (in.)	metric (cm.)	imperial (in.)	metric (cm.)	imperial (in.)	metric (cm.)	imperial (in.)	metric (cm.)	
inside area	70.7 sq. ft.	6.7 sq. m.	85.3 sq. ft.	8.08 sq. m.	113.7 sq. ft.	10.77 sq. m.	142.08 sq. ft.	13.46 sq. m.	
H									
E	A	105	2667	105	2667	105	2667	105	2667
I	B	94	2388	94	2388	94	2388	94	2388
G	C	80	2032	80	2032	80	2032	80	2032
H	D	75 1/4	1911	75 1/4	1911	75 1/4	1911	75 1/4	1911
T									
W									
I	E	105	2667	105	2667	105	2667	105	2667
D	F	93	2362	93	2362	93	2362	93	2362
T	G	88	2235	88	2235	88	2235	88	2235
H									
D									
E	H	132	3353	156	3963	202	5131	248 1/2	6312
P	I	120 1/2	2064	144 1/2	3674	191	4851	237 1/2	6033
T	J	115 5/8	2937	139 1/2	3543	186	4724	232 1/2	5906
H									

NOTE: When the 7 ft wall option is purchased the all the HEIGHT measurements will be 12" (30.5 cm) larger.

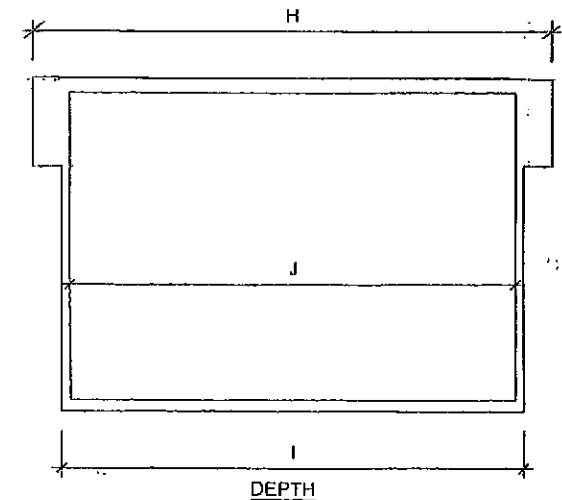
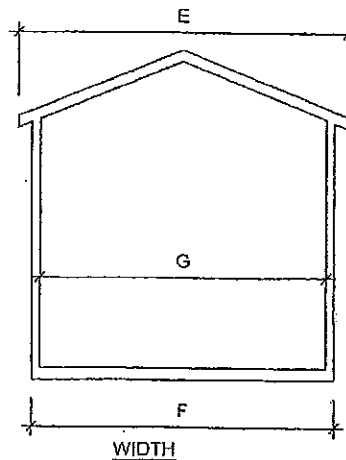

GABLE GARDEN SHED (10 Ft Wide) MEASUREMENTS

The specifications outlined here are the basic measurements for the gable garden sheds. For specifications for any unique styles of sheds please refer to the specific pages for each model included in this book.

All window and door dimensions are outlined in the individual product information sheets.

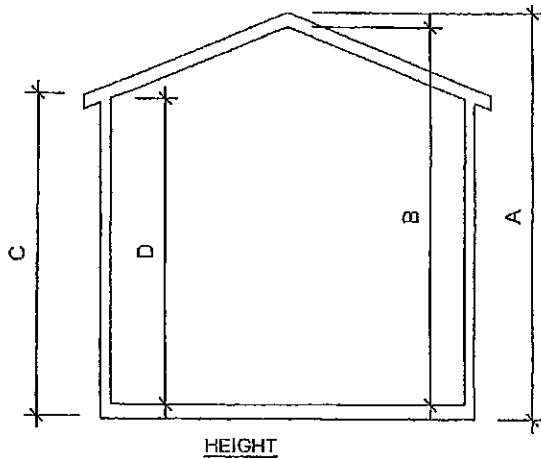

PLEASE NOTE SPECIALTY SHEDS, SUCH AS THE SUNHOUSE, PLAYHOUSES, AND LEAN TO STYLE SHEDS WILL HAVE THEIR OWN SPECIFICATION SHEETS INCLUDED IN THIS BOOK.

MEASUREMENTS FOR GABLE SHEDS									
10 FT. GABLE WALL									
SIZE	8' x 10' or 10' x 8'		10' x 12' or 12' x 10'		10' x 16' or 16' x 10'		10' x 20' or 20' x 10'		
	imperial (in.)	metric (cm.)	imperial (in.)	metric (cm.)	imperial (in.)	metric (cm.)	imperial (in.)	metric (cm.)	
inside area	88.6 sq. ft.	8.4 sq. m.	107.1 sq. ft.	10.14 sq. m.	142.7 sq. ft.	13.52 sq. m.	178.4 sq. ft.	16.9 sq. m.	
H									
E	A	112	2845	112	2845	112	2845	112	2845
I	B	100	2540	100	2540	100	2540	100	2540
G	C	80	2032	80	2032	80	2032	80	2032
H	D	75 1/4	1911	75 1/4	1911	75 1/4	1911	75 1/4	1911
T									
W									
I	E	128 1/2	3264	128 1/2	3264	128 1/2	3264	128 1/2	3264
D	F	115 1/2	2934	115 1/2	2934	115 1/2	2934	115 1/2	2934
T	G	110 1/2	2807	110 1/2	2807	110 1/2	2807	110 1/2	2807
H									
D									
E	H	132	3353	156	3963	202	5131	248 1/2	6312
P	I	120 1/2	2064	144 1/2	3674	191	4851	237 1/2	6033
T	J	115 5/8	2937	139 1/2	3543	186	4724	232 1/2	5906
H									

NOTE: When the 7 ft wall option is purchased the all the HEIGHT measurements will be 12" (30.5 cm) larger.

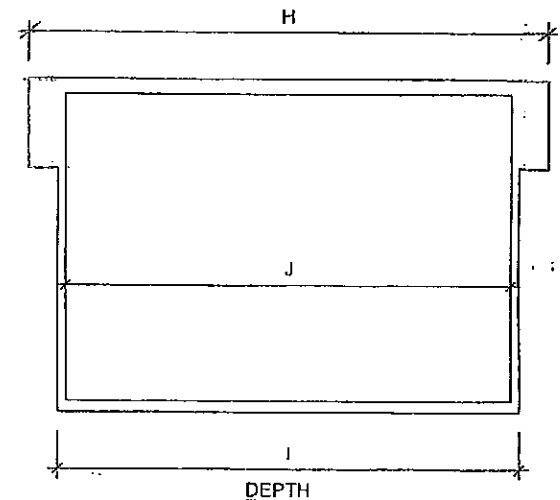
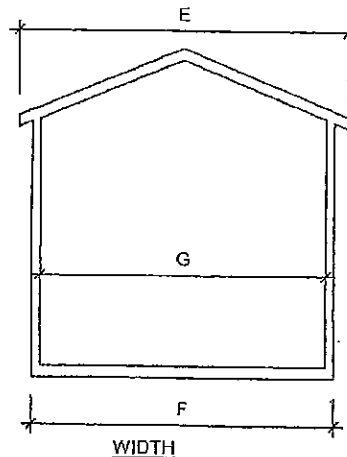

GARDENER'S DELIGHT SHED SPECIFICATION

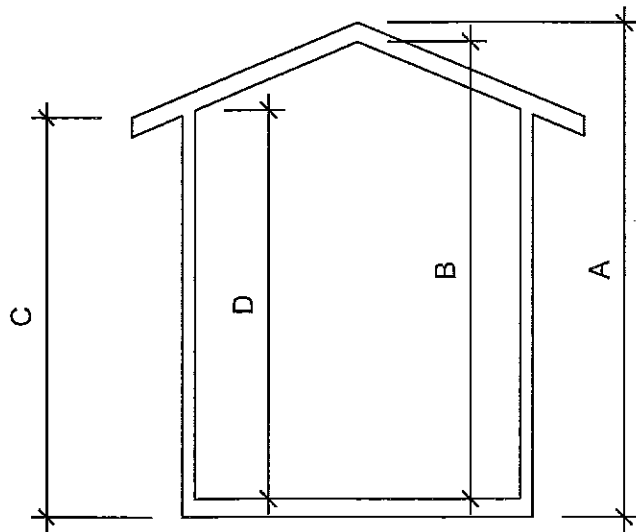

HEIGHT

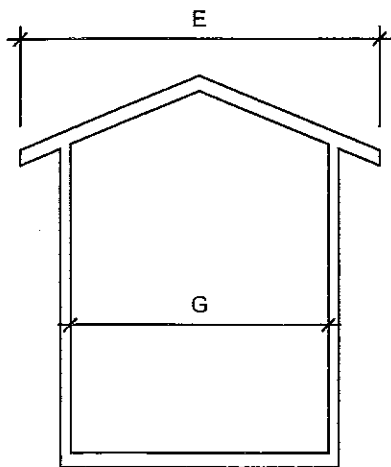

WIDTH

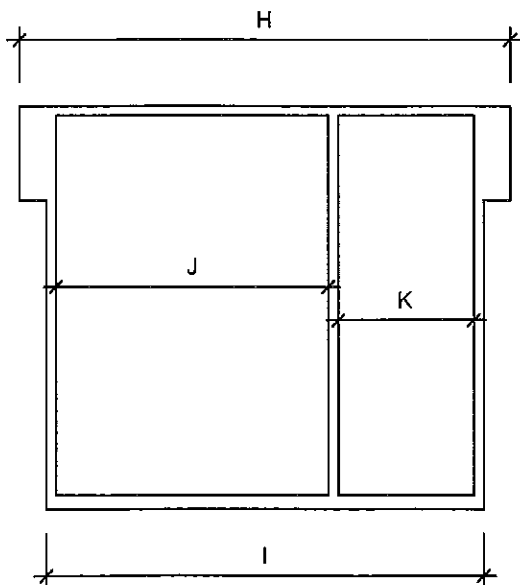

DEPTH

Western Red Cedar shingle roof
All framing components are nominal 2"x3"
Floors consist of 2"x4" joist and 5/8" plywood
Siding is Wood Bevel Siding
Windows are made of cedar framing with 1/8" thick Plexiglas.

Measurements for Gardener's Delight Shed		
Dimension (metric in brackets)		
Size	6' x 9' (1829x2793)	
Inside Area	32 Sq. Ft. (2.98 m ²)	
Height	A	99" (2515)
	B	88" (2235)
	C	80" (2032)
	D	75 1/4" (1905)
Width	E	83" (2108)
	F	69" (1753)
	G	64" (1627)
Depth	H	122" (3099)
	I	108 5/8" (2759)
	J	74" (1880)
	K	34" (864)
	Door	29 1/2"x72" (749x1828)
Window Opening	24"Wx28"H (610x711) 2 - Functional awning windows	
Window Opening	23"Wx25 1/4"H (584x641) Non-functional window	
Weight	955 lbs (433.19 kg)	
Package Size	80"Lx48"Wx48"H(2032x1219x1219)	

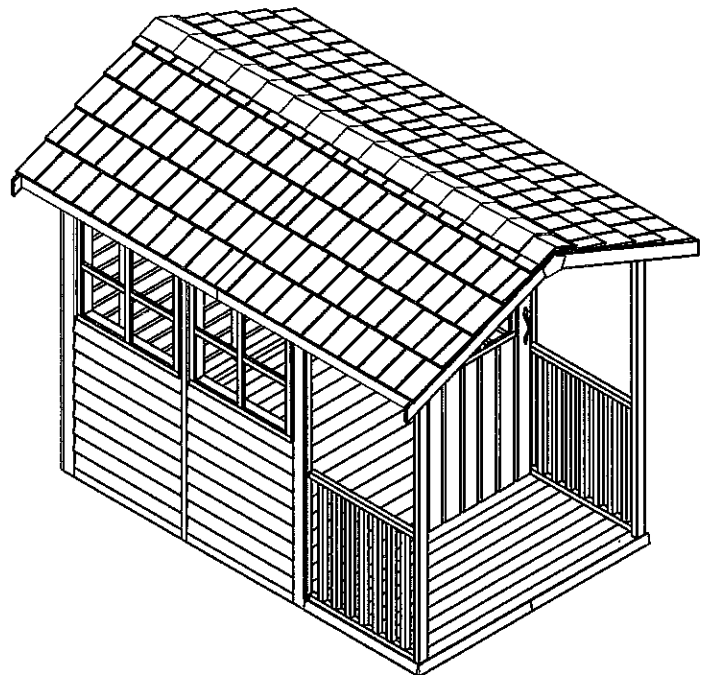

CLUBHOUSE SPECIFICATION

Western Red Cedar Shingle Roof
 All framing components are nominal 2"x3" in size
 2"x3" floor joists on 16" centers
 Wood siding is Bevel Siding
 Window panel can be placed on any side of the shed
 All windows are plexi glass windows - 1/8" thick

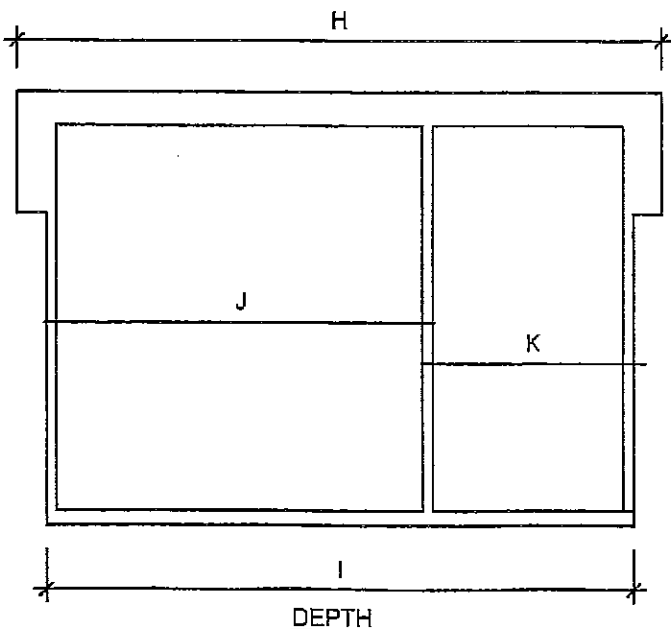
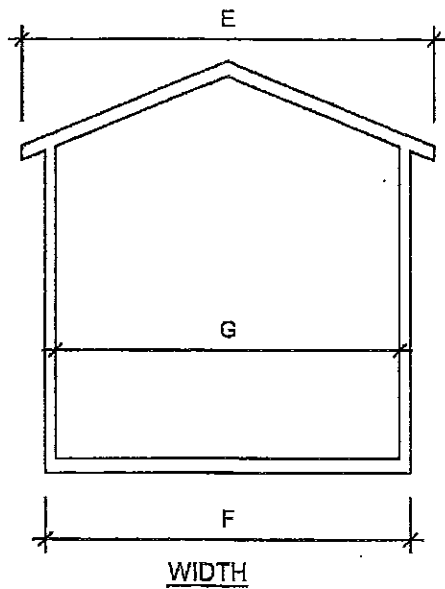
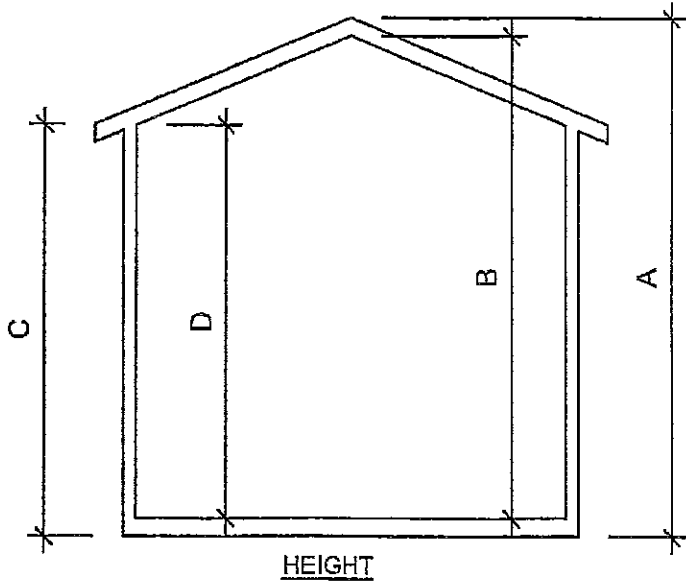

MEASUREMENTS FOR THE CLUBHOUSE GABLE SHED					
SIZE	8' X 12'		8' X 16'		
	imperial (in.)	metric (cm.)	imperial (in.)	metric (cm.)	
inside area	56.8 sq. ft.	5.4 sq. m.	85.3 sq. ft.	8.08 sq. m.	
H					
E	A	105	2667	105	2667
I	B	93	2362	93	2362
G	C	88	2235	88	2235
H	D	75 1/4	1911	75 1/4	1911
T					
W					
I	E	105	2667	105	2667
D	F	93	2362	93	2362
T	G	88	2235	88	2235
H					
D					
E	H	156	3963	202	5131
P	I	144 1/2	3674	191	4851
T	J	93	2362	139 1/2	3543
H	K	46 1/2	1181	46 1/2	1181
Door					
		72 H	1829 H	72 H	1829 H
		35 1/4 W	895 W	35 1/4 W	895 W
window opening		28 H	711 H	28 H	711 H
		24 W	610 W	24 W	610 W
		2-functional windows awning (push out)		2-functional windows awning (push out)	
window opening		34 H	864 H	34 H	864 H
		40 W	1016 W	40 W	1016 W
		functional window sliding front		functional window sliding front	

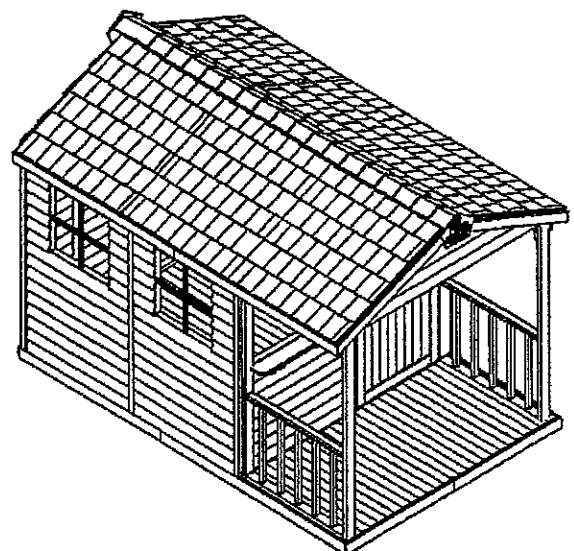

BAYSIDE SHED SPECIFICATION

Revised 07/25/07

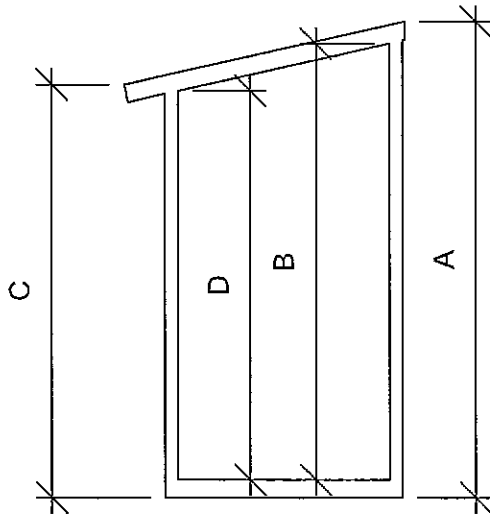

HEIGHT

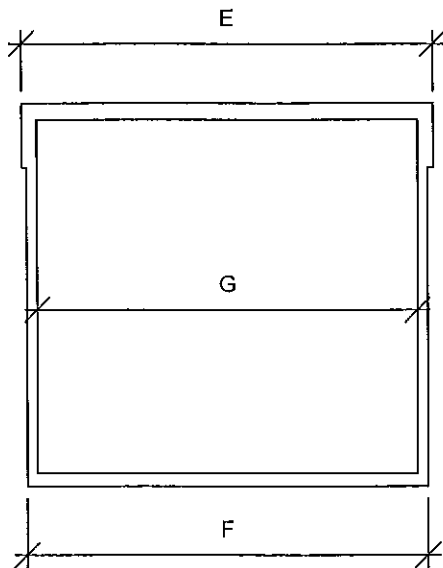

WIDTH

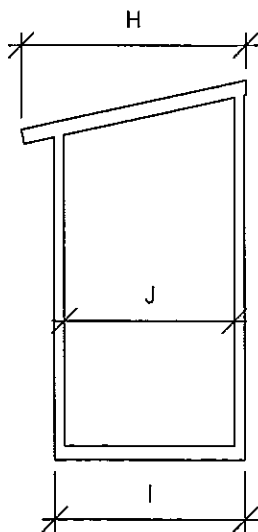

DEPTH

Western Red Cedar Shingle Roof
 All framing components are nominal 2"x3" in size
 2"x3" floor joists on 16" centers
 Wood siding is Bevel Siding
 Window panel can be placed on any side of the shed
 All windows are plexi glass windows - 1/8" thick

Measurements for Bayside Shed	
Dimension (metric in brackets)	
Size	8' x 4' (2438x1219)
Inside Area	26.39 Sq. Ft. (2.45 m ²)
Height	A 93" (2362)
	B 86" (2184)
	C 80" (2032)
	D 75 1/4" (1911)
Width	E 100" (2540)
	F 98" (2489)
	G 95" (2413)
Depth	H 52" (1321)
	I 43" (1092)
	J 40" (1219)
	Door
Window Opening	23"Wx25 1/4"H (584x641)
	23"Wx25 1/4"H (584x641)
Weight	575 lbs (260.82 kg)
Package Size	87"Lx50"Wx30"H(2210x1270x762)

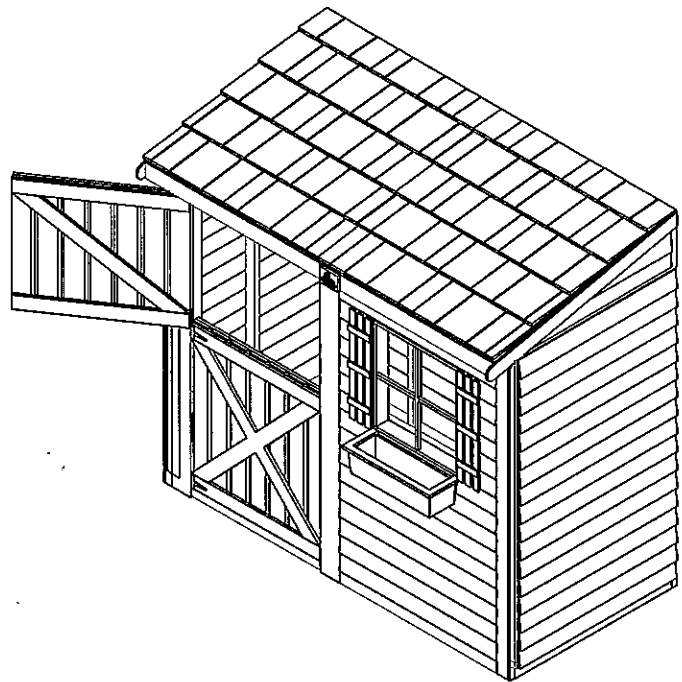

YARDSAVER GARDEN SHED SPECIFICATION

Revised 07/26/07

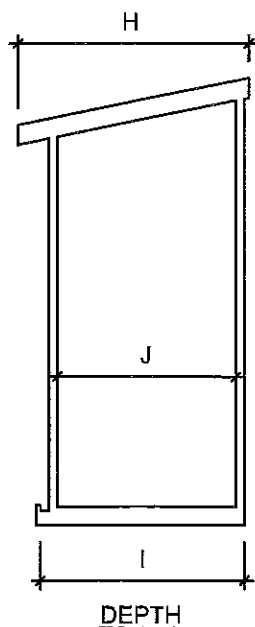
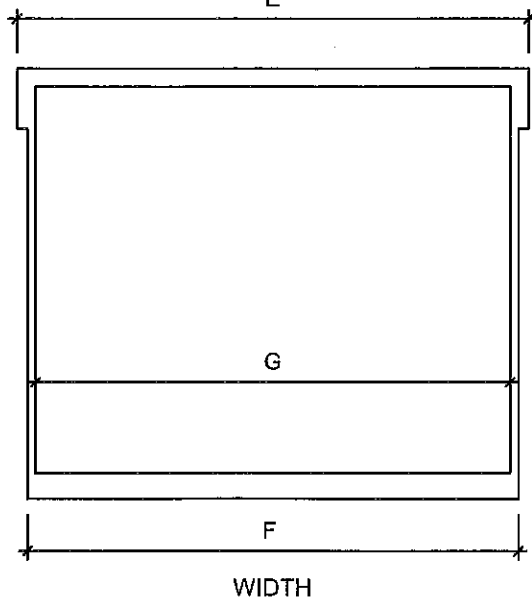
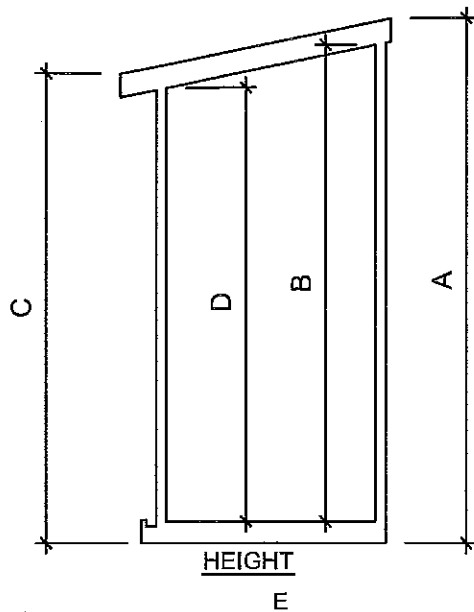

Western Red Cedar Shingle Roof
 All framing components are nominal 2"x3" in size
 2"x3" floor joists on 16" centers
 Wood siding is Bevel Siding
 Window panel can be placed on front left or right side of the shed
 All windows are plexi glass windows - 1/8" thick

Measurements for Yardsaver		
Dimemsion (metric in brackets)		
Size	8' x 3' (2438x914)	
Inside Area	19.03 Sq. Ft. (1.77 m ²)	
Height	A	80" (2032)
	B	72" (1829)
	C	68" (1727)
	D	63 1/2" (1613)
Width	E	94" (2388)
	F	90" (2286)
	G	87" (2210)
Depth	H	44" (1118)
	I	36" (914)
	J	31 1/2" (800)
Door	44"x66" (1118x1676)	
Window Opening	16 1/4"Wx25 1/4"H (413x641) Non-functional window	
Weight	450 lbs (204.12 kg)	
Package Size	93"Lx44"Wx25"H (2362x1118x635)	

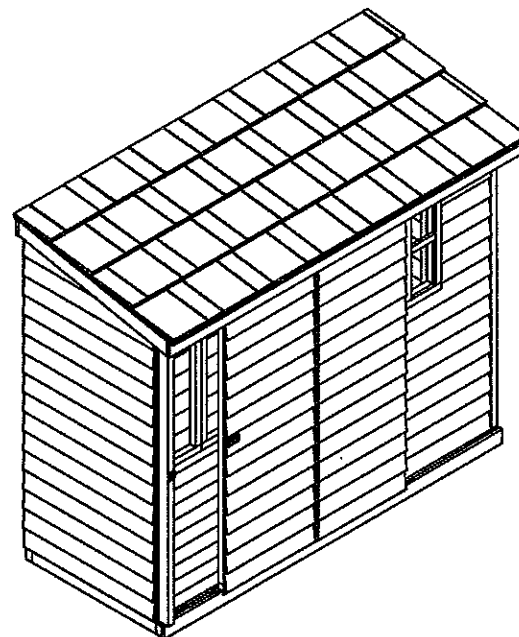

BANFF SHED SPECIFICATION

Revised 07/25/07

Western Red Cedar Shingle Roof
 All framing components are nominal 2"x2" in size
 2"x2" floor joists on 16" centers
 Wood siding is Bevel Siding
 Window panel can be placed any side of the shed
 All windows are plexi glass windows - 1/8" thick

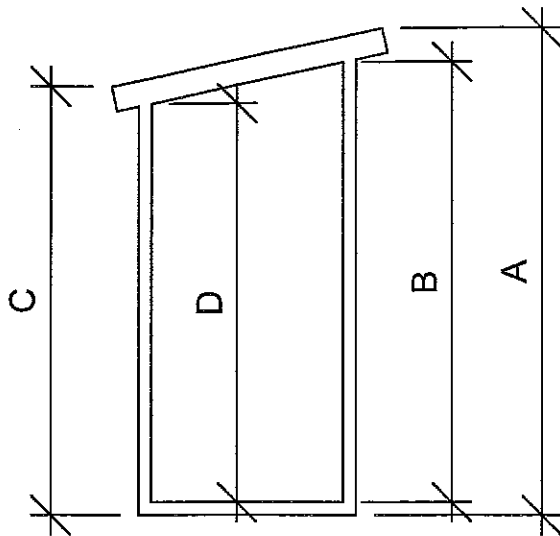

HEIGHT

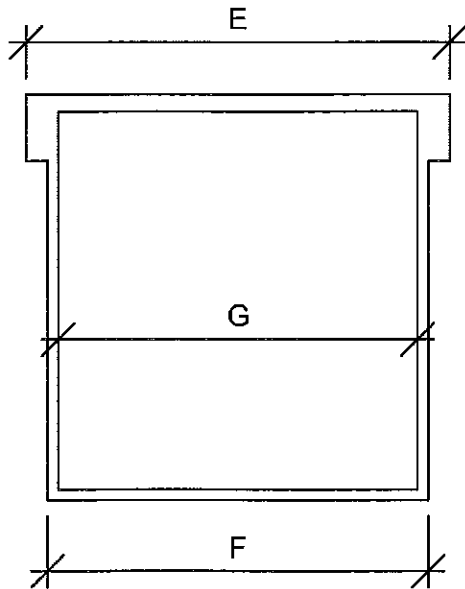

WIDTH

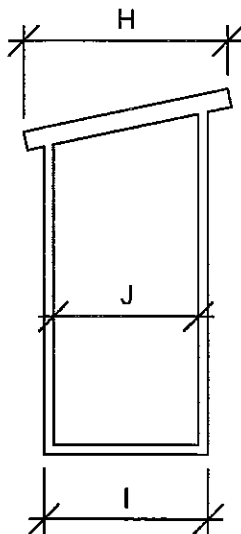

DEPTH

Measurements for Banff Shed	
Dimension (metric in brackets)	
Size	6' x 3' (1829x914)
Inside Area	14.32 Sq. Ft. (1.33 m ²)
Height	A 77 1/2" (1966)
	B 70 1/2" (1778)
	C 68" (1727)
	D 63 1/2" (1613)
Width	E 77 1/2" (1966)
	F 69 1/2" (1765)
	G 66 1/2" (1689)
Depth	H 43" (1092)
	I 34" (864)
	J 31 1/2" (800)
	Door
Window Opening	16 1/4"Wx25 1/4"H (413x641) Non-functional window
Weight	350 lbs (158.76 kg)
Package Size	87"Lx48"Wx25"H(2210x1219x635)

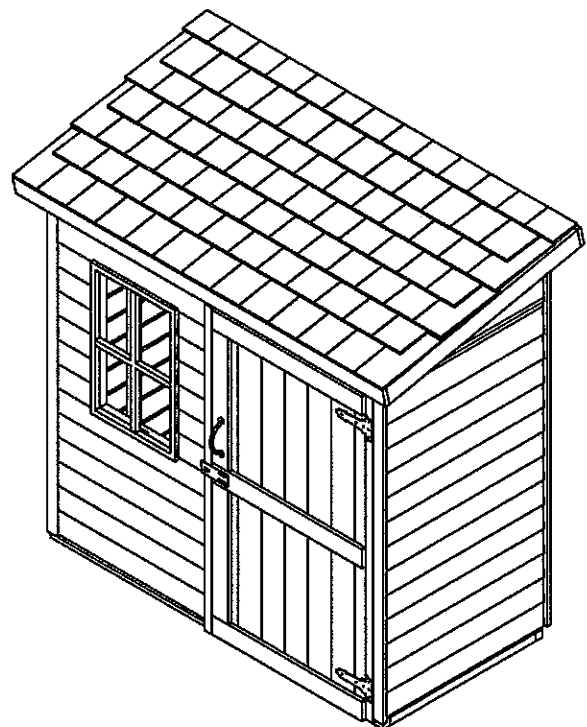

SUNHOUSE SPECIFICATION

Western Red Cedar Shingle Roof

All framing components are nominal 2"x3" in size

2"x3" floor joists on 16" centers

Wood siding is Bevel Siding

Window panel can be placed on any side of the shed

All windows are plexi glass windows - 1/8" thick

Lexan (polycarbonate) long roof section

Lexan roof panel 1/4" thick

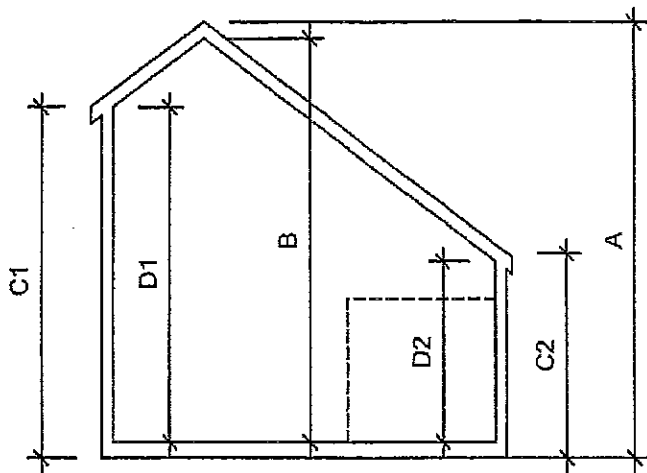

HEIGHT

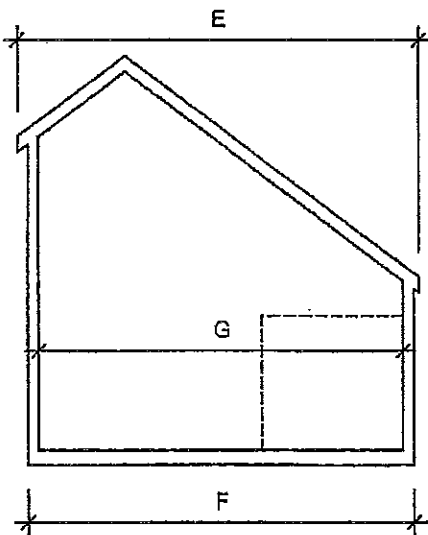

WIDTH

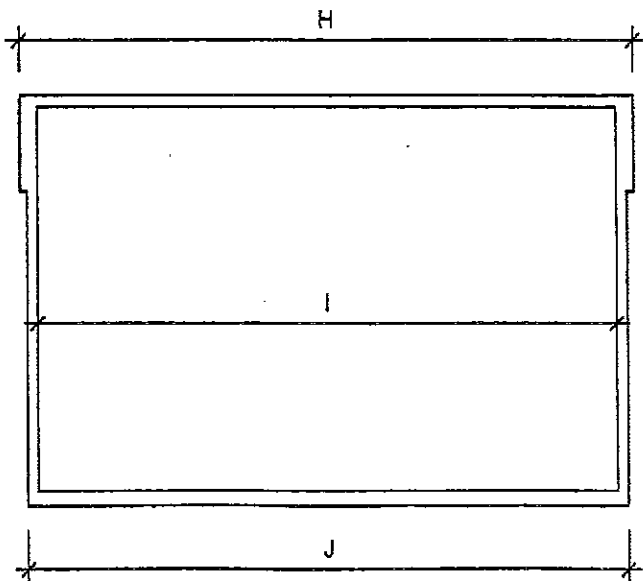

DEPTH

8'x8' SunHouse
2 benches

8'x12' SunHouse
3 benches

MEASUREMENTS FOR GREENHOUSE STYLE SHEDS					
SUNHOUSE					
SIZE	8' x 8'		8' x 12'		
	imperial (in.)	metric (cm.)	imperial (in.)	metric (cm.)	
inside area	56.8 sq. ft.	5.4 sq. m.	85.3 sq. ft.	8.08 sq. m.	
H	A	102	2591	102	2591
E	B	92	2337	92	2337
I	C1	80	2032	80	2032
G	C2	45	1143	45	1143
H	D1	75 1/4	1911	75 1/4	1911
T	D2	41	1041	41	1041
W					
I	E	96	2667	105	2667
D	F	93	2362	93	2362
T	G	88	2235	88	2235
H					
D					
E	H	109 1/2	3353	156	3963
P	I	93	2064	144 1/2	3674
T	J	98	2937	139 1/2	3543
H					
	Bench	32 H	813 H	32 H	813 H
		34 W	864 W	34 W	864 W
		46 D	1168 D	46 D	1168 D
	Door	72 H	1829 H	72 H	1829 H
		35 1/4 W	895 W	35 1/4 W	895 W
	window	28 H	711 H	28 H	711 H
	opening	24 W	610 W	24 W	610 W
		functional awning (push out) window		functional awning (push out) window	

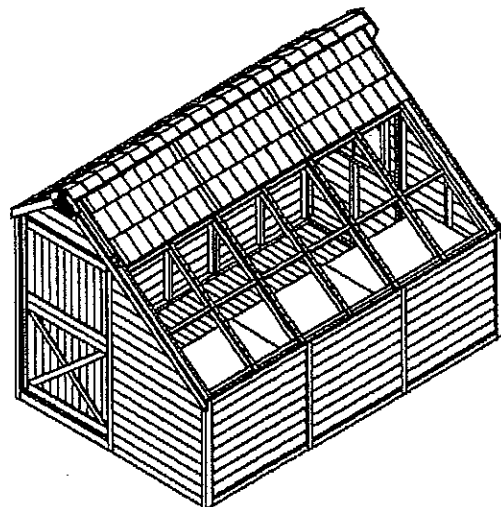

PLAYHOUSE SPECIFICATION

Revised 07/26/07

Western Red Cedar Shingle Roof
 All framing components are nominal 2"x3" in size
 2"x3" floor joists on 16" centers
 Wood siding is Bevel Siding

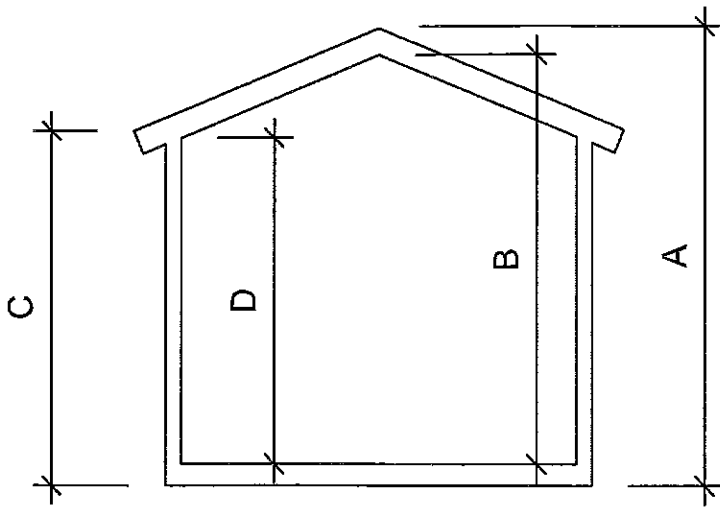

HEIGHT

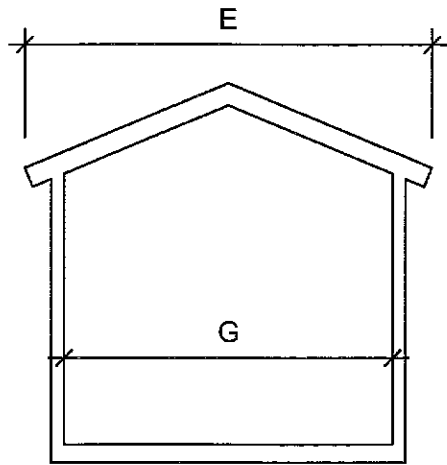

F

WIDTH

H

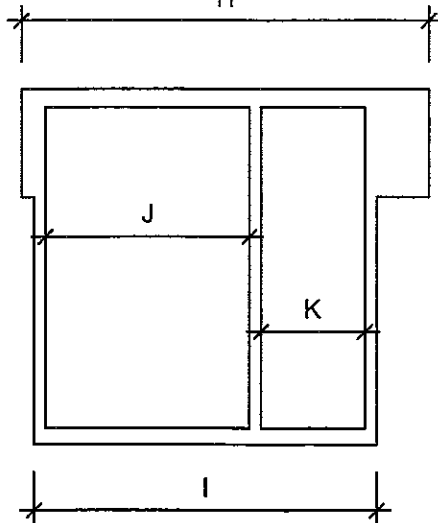

DEPTH

Measurements for Playhouse	
Dimension (metric in brackets)	
Size	6' x 6' (1829x1829)
Inside Area	20.44 Sq. Ft. (1.89 m ²)
Height	A 73" (1854)
	B 67" (1702)
	C 51" (1295)
	D 48" (1219)
Width	E 83" (2108)
	F 69" (1753)
	G 64" (1626)
Depth	H 87" (2210)
	I 69" (1753)
	J 46" (1168)
	K 23" (584)
	Door
Window Opening	16 1/2"Wx16 1/2"H (419x419) Functional window with shutters
Weight	700 lbs (317.52 kg)
Package Size	87"Lx50"Wx30"H(2210x1270x762)

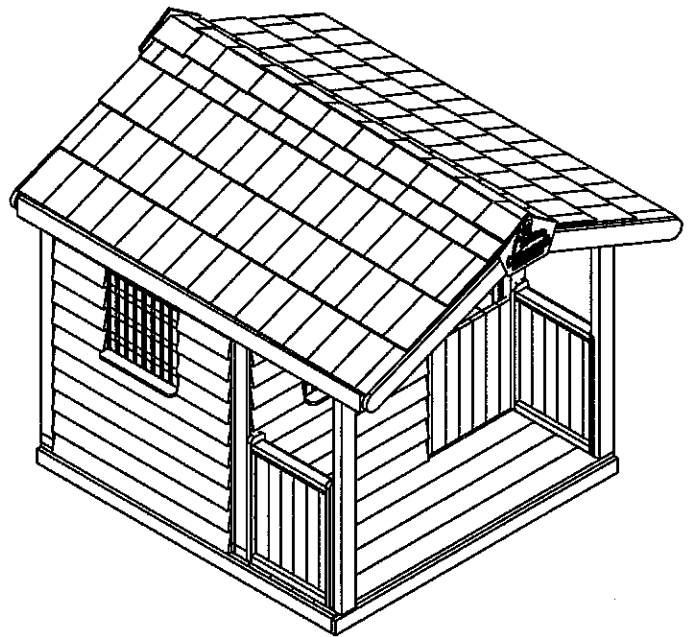

HEXAGON GAZEBO SPECIFICATIONS

All Gazebos are constructed of 100% Western Red Cedar.
 All framing components are nominal 2x4 in size.
 Wall posts consist of 2 - 2x4 fastened together.

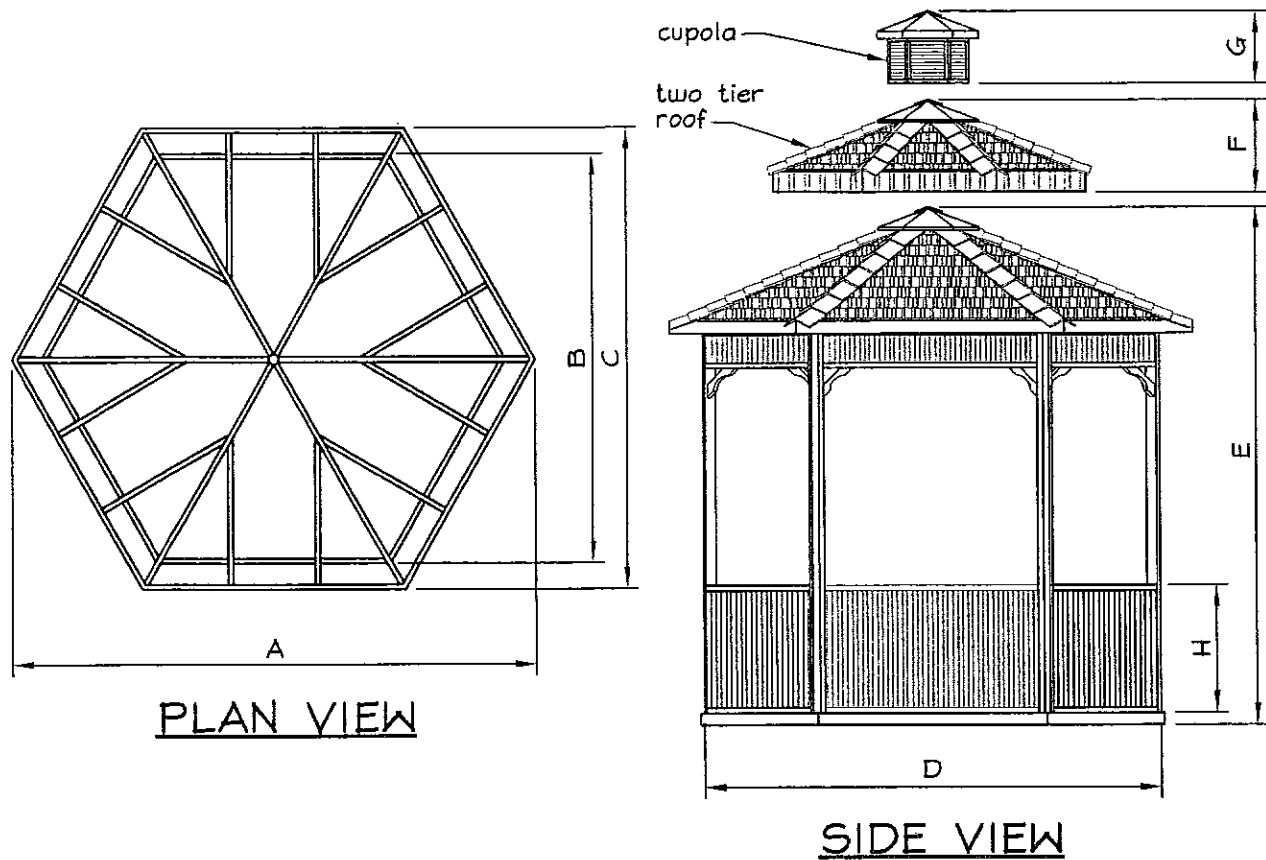

MEASUREMENTS FOR HEXAGON GAZEBO		
DIMENSIONS -Imperial-(Metric)		
SIZE	8 ft	10 ft
Area	85 sq. ft (8.05 sq. m.)	106 sq. ft. (10.04 sq. m.)
A	136 in. (3.45 m.)	154 in. (3.91 m.)
B	96 in. (2.44 m.)	118 in. (3.00 m.)
C	116 in. (2.95 m.)	133 in. (3.38 m.)
D	111 in. (2.82 m.)	136 in. (3.45 m.)
E	118 in. (3.00 m.)	124 in. (3.15 m.)
F	12 in. (30.5 cm.)	12 in. (30.5 cm.)
G	12 in. (30.5 cm.)	12 in. (30.5 cm.)
H	37 in. (94 cm.)	37 in. (94 cm.)
Door opening	50 in. wide x 73 in. high 1.27 m wide x 1.85 m. high	62 in. wide x 73 in. high 1.58 m. wide x 1.85 m. high
Screen door opening	34 in. wide x 79 in. high 86.4 cm. wide x 2.01 m. high	34 in. wide x 79 in. high 86.4 cm. wide x 2.01 m. high

ALL SEASON HEXAGON GAZEBO SPECIFICATIONS

All Gazebos are constructed of 100% Western Red Cedar.
 All framing components are nominal 2x4 in size.
 Wall posts consist of 2 - 2x4 fastened together.

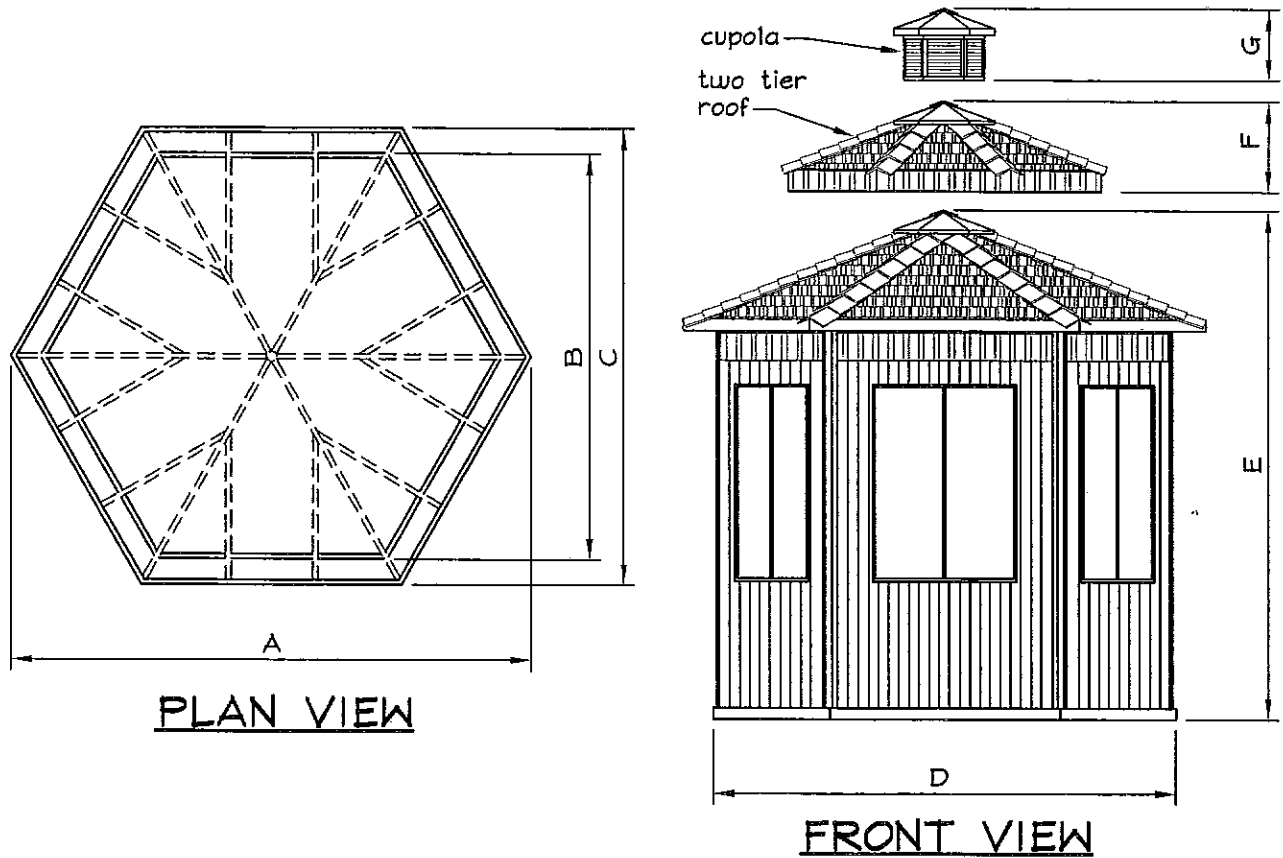

MEASUREMENTS FOR HEXAGON GAZEBO (ALL SEASON)	
DIMENSIONS -Imperial-(Metric)	
SIZE	10 ft
Area	106 sq. ft. (10.04 sq. m.)
A	154 in. (3.91 m.)
B	118 in. (3.00 m.)
C	133 in. (3.38 m.)
D	136 in. (3.45 m.)
E	124 in. (3.15 m.)
F	12 in. (30.5 cm.)
G	12 in. (30.5 cm.)
H	37 in. (94 cm.)
Door size	43 in. wide x 74 3/4 in. high 1.09 m. wide x 1.90 m. high
window size	41 3/4 in. wide x 41 3/4 in. high 1.06 m. wide x 1.06 m. high

OCTAGON GAZEBO SPECIFICATIONS

All Gazebos are constructed of 100% Western Red Cedar.
 All framing components are nominal 2x4 in size.
 Wall posts consist of 2 - 2x4 fastened together.

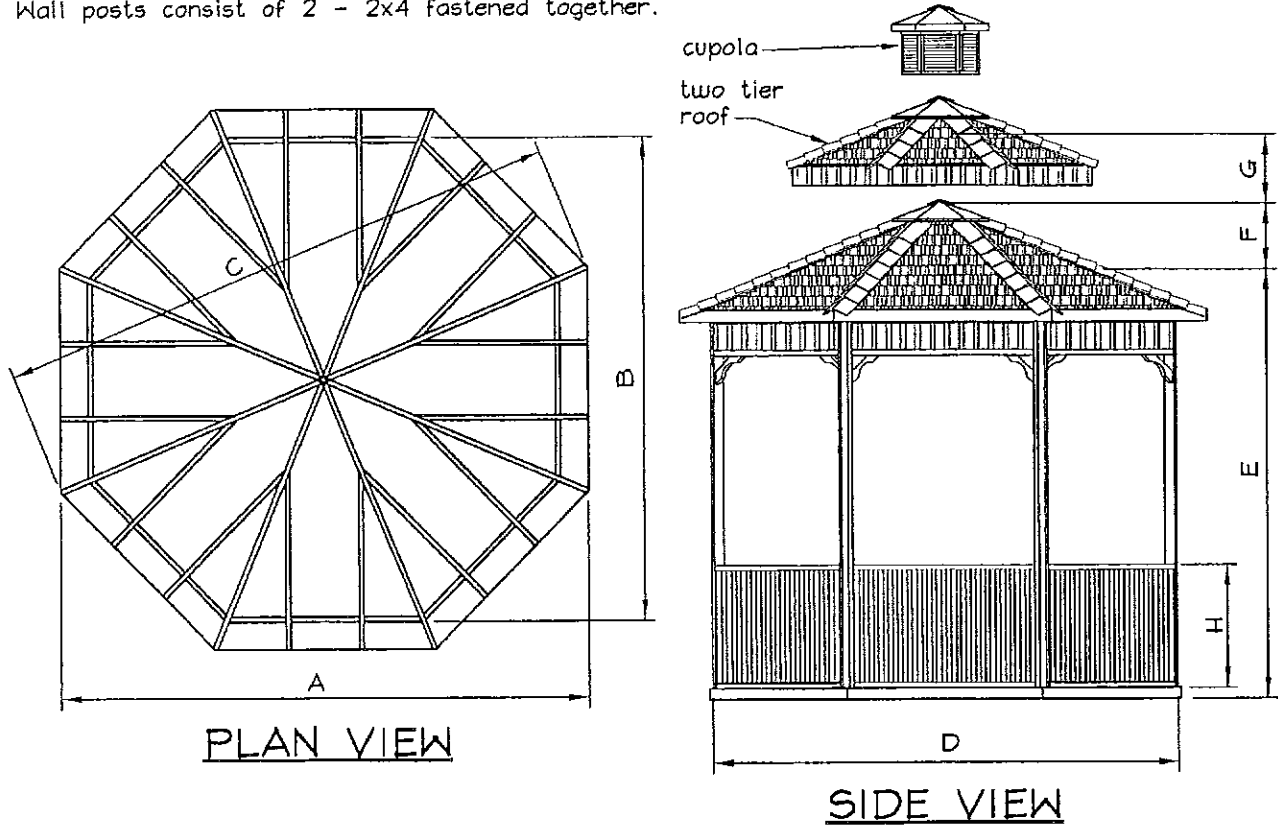

MEASUREMENTS FOR OCTAGON GAZEBO		
DIMENSIONS -Imperial-(Metric)		
SIZE	12 ft	14 ft
Area	120 sq. ft (11.36 sq. m.)	154 sq. ft. (14.58 sq. m.)
A	162 in. (4.11 m.)	187 in. (4.75 m.)
B	145 in. (3.68 m.)	168 in. (4.27 m.)
C	180 in. (4.57 m.)	202 in. (5.13 m.)
D	156 in. (3.96 m.)	181 in. (4.6 m.)
E	128 in. (3.25 m.)	118 in. (3.00 m.)
F	12 in. (30.5 cm.)	12 in. (30.5 cm.)
G	12 in. (30.5 cm.)	12 in. (30.5 cm.)
H	37 in. (94 cm.)	37 in. (94 cm.)
Door opening	55 in. wide x 73 in. high 1.40 m wide x 1.85 m. high	64 in. wide x 73 in. high 1.63 m. wide x 1.85 m. high
Screen door opening	34 in. wide x 79 in. high 86.4 cm. wide x 2.01 m. high	34 in. wide x 79 in. high 86.4 cm. wide x 2.01 m. high

ALL SEASON OCTAGON GAZEBO SPECIFICATIONS

All Gazebos are constructed of 100% Western Red Cedar.
 All framing components are nominal 2x4 in size.
 Wall posts consist of 2 - 2x4 fastened together.

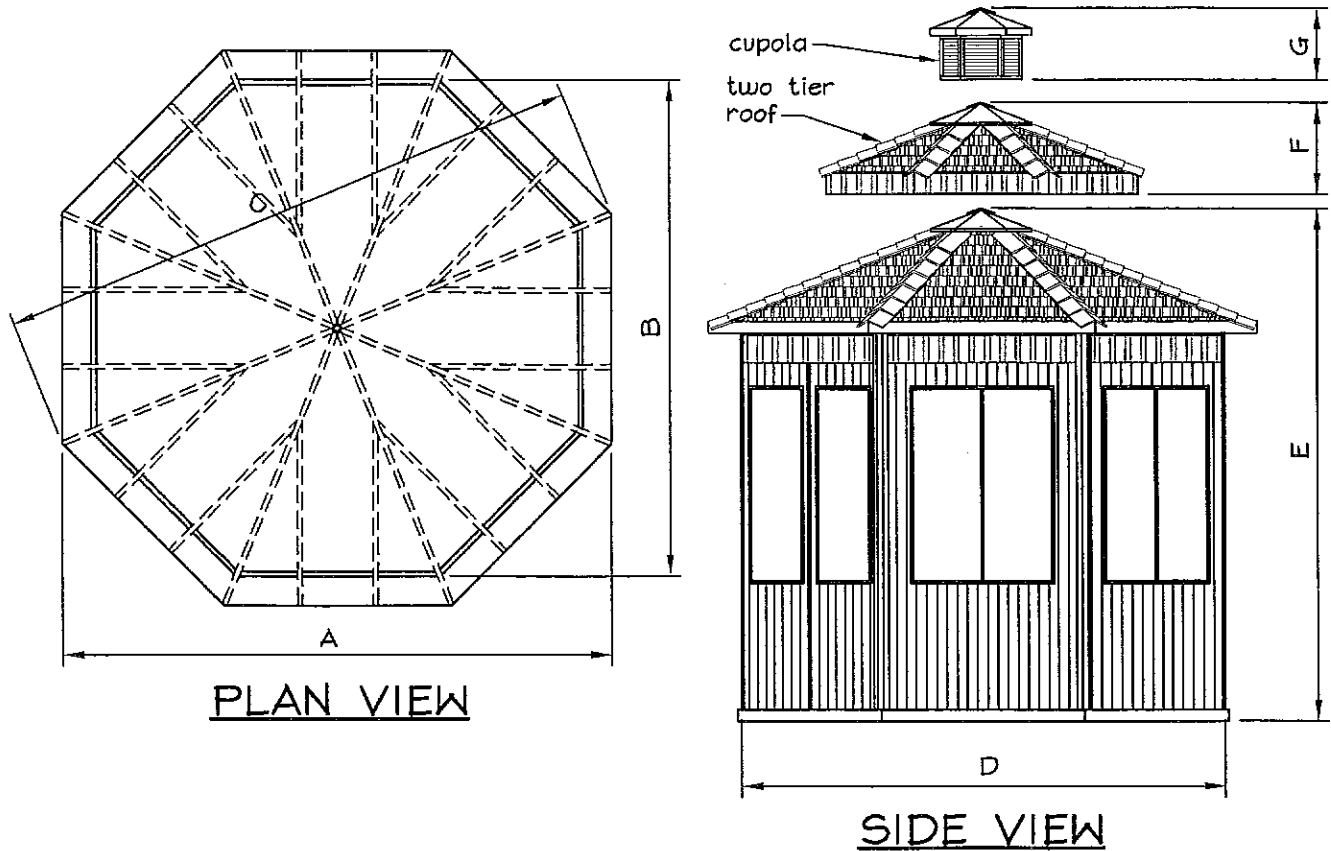

MEASUREMENTS FOR OCTAGON GAZEBO (ALL SEASON)		
DIMENSIONS -Imperial-(Metric)		
SIZE	12 ft	14 ft
Area	120 sq. ft (11.36 sq. m.)	154 sq. ft. (14.58 sq. m.)
A	162 in. (4.11 m.)	187 in. (4.75 m.)
B	145 in. (3.68 m.)	168 in. (4.27 m.)
C	180 in. (4.57 m.)	202 in. (5.13 m.)
D	156 in. (3.96 m.)	181 in. (4.6 m.)
E	128 in. (3.25 m.)	118 in. (3.00 m.)
F	12 in. (30.5 cm.)	12 in. (30.5 cm.)
G	12 in. (30.5 cm.)	12 in. (30.5 cm.)
H	37 in. (94 cm.)	37 in. (94 cm.)
Door size	43 in. wide x 74 3/4 in. high 1.09 m. wide x 1.90 m. high	43 in. wide x 74 3/4 in. high 1.09 m. wide x 1.90 m. high
window size	41 3/4 in. wide x 41 3/4 in. high 1.06 m. wide x 1.06 m. high	41 3/4 in. wide x 41 3/4 in. high 1.06 m. wide x 1.06 m. high

SQUARE GAZEBO SPECIFICATIONS

All Gazebos are constructed of 100% Western Red Cedar.
 All framing components are nominal 2"x4" in size.
 Wall posts consist of 2 - 2"x4" fastened together.

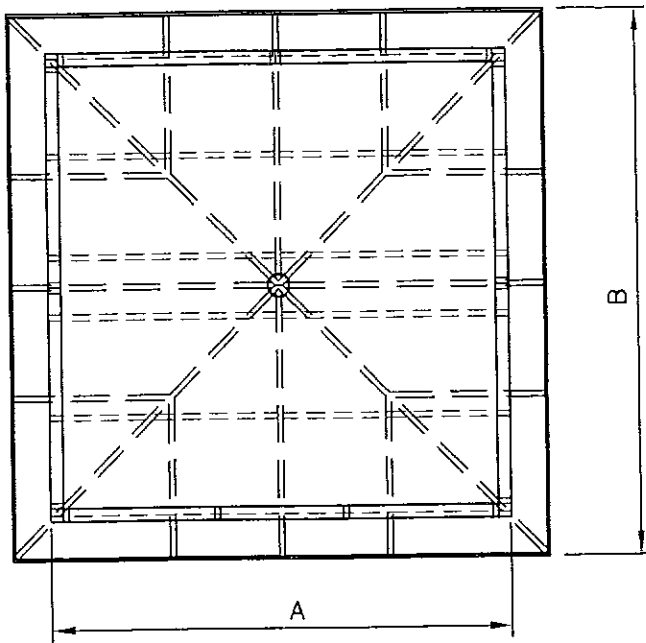

PLAN VIEW

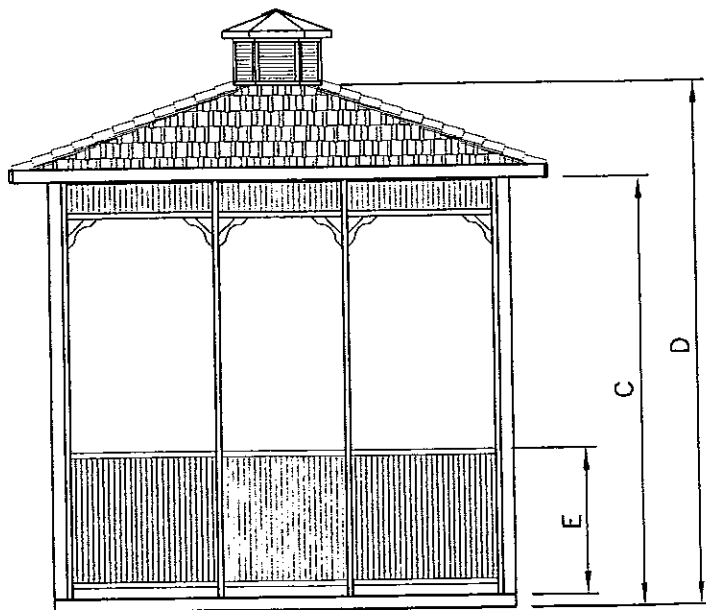

SIDE VIEW

MEASUREMENTS FOR SQUARE GAZEBO	
DIMENSIONS -Imperial-(Metric)	
SIZE	10 ft square (open)
Area	100 sq. ft. (9.48 sq. m.)
A	127 in. (3.23 m.)
B	147 in. (3.73 m.)
C	114 in. (2.90 m.)
D	124 in. (3.15 m.)
E	37 in. (94 cm.)
Door size	34 in. wide x 73 in. high 86 cm. wide x 2.01 m. high
Screen door opening	34 in. wide x 79 in. high 86.4 cm. wide x 2.01 m. high
MEASUREMENTS FOR SQUARE GAZEBO (ALL SEASON)	
DIMENSIONS -Imperial-(Metric)	
SIZE	10 ft square (open)
Area	100 sq. ft. (9.48 sq. m.)
A	127 in. (3.23 m.)
B	147 in. (3.73 m.)
C	114 in. (2.90 m.)
D	124 in. (3.15 m.)
E	37 in. (94 cm.)
Door size	43 in. wide x 74 3/4 in. high 1.09 m. wide x 1.90 m. high
window size	41 3/4 in. wide x 41 3/4 in. high 1.06 m. wide x 1.06 m. high

Specifications for 10' x 12' & 10' x 15' Gazebos

- Your Gazebo is constructed of Western Red Cedar.
- All framing components are nominal 2"x 4" in size (unless noted otherwise)

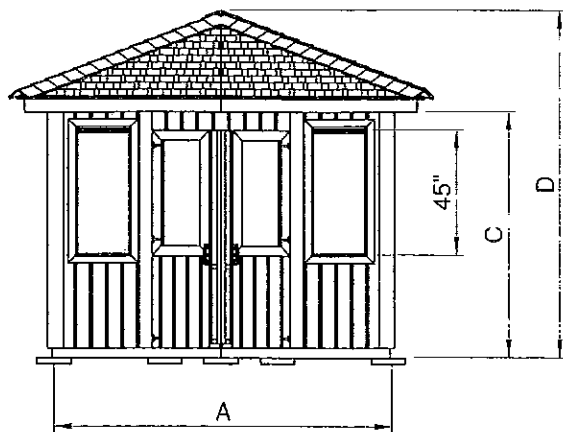

FRONT VIEW

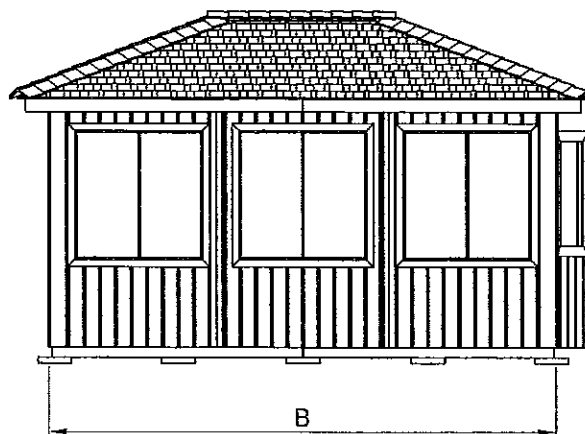

SIDE VIEW

MEASUREMENTS FOR RECTANGLE GAZEBO (ALL SEASON)		
DIMENSIONS -Imperial-(Metric)		
SIZE	10 ft x 12 ft	10 ft x 15 ft
Area	118 sq. ft (11.17 sq. m.)	146 sq. ft. (13.82 sq. m.)
A	119 in. (3.02 m.)	119 in. (3.02 m.)
B	143 in. (3.63 m.)	176 1/2 in. (4.48 m.)
C	89 in. (2.26 m.)	89 in. (2.26 m.)
D	118 in. (3.00 m.)	118 in. (3.00 m.)
Door size	43 in. wide x 74 3/4 in. high 1.09 m. wide x 1.90 m. high	43 in. wide x 74 3/4 in. high 1.09 m. wide x 1.90 m. high
window size	41 3/4 in. wide x 41 3/4 in. high 1.06 m. wide x 1.06 m. high	41 3/4 in. wide x 41 3/4 in. high 1.06 m. wide x 1.06 m. high

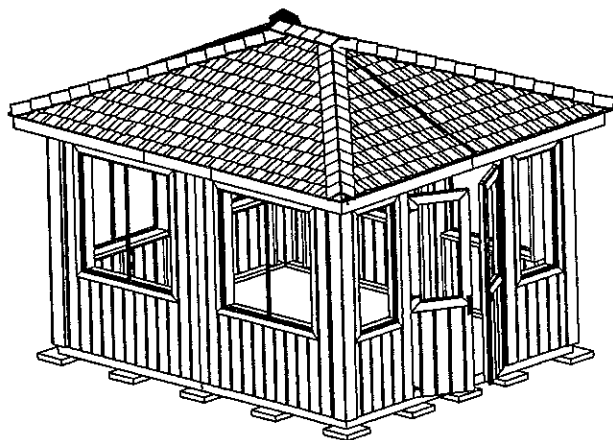

10' x 12'

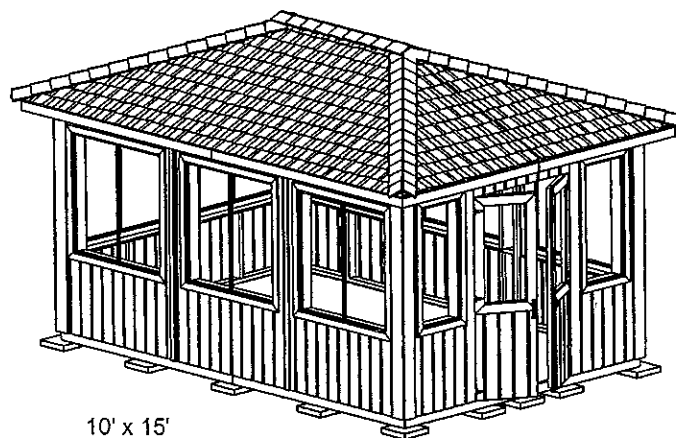

10' x 15'